

TOP VIEW

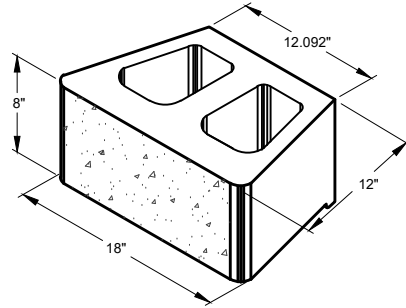

FRONT VIEW

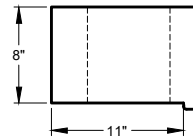

SIDE VIEW

LARGE UNIT

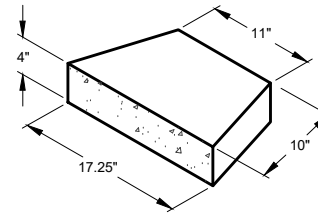

CAP UNIT

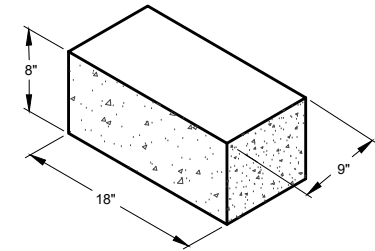

CORNER UNIT

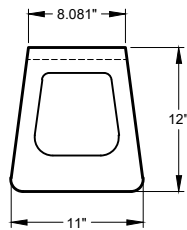

TOP VIEW

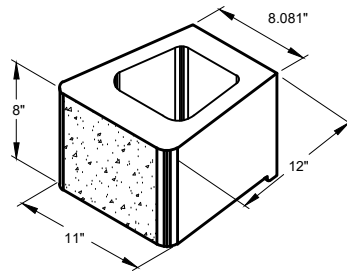

FRONT VIEW

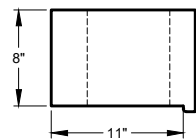

SIDE VIEW

MEDIUM UNIT

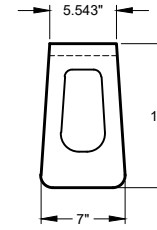

TOP VIEW

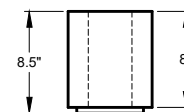
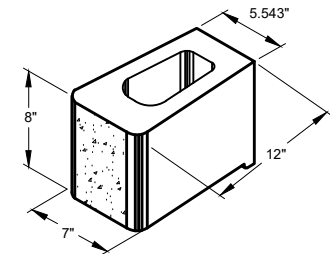

FRONT VIEW

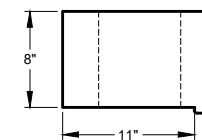

SIDE VIEW

SMALL UNIT



ANCHOR
DIAMOND

This drawing is for illustrative purposes only and should not be used for construction without the signature of a registered professional engineer.

www.anchordiamond.com

© 2022 ANCHOR Engineering, LLC® and © 2022 ANCHOR DIAMOND®

Diamond Pro® Retaining Wall System

Individual Block Details - Stone Cut Multi Piece Face

Scale:	1/4" = 1'-0"	Drawn by:	SB
Date:	8/8/2022	Drawing number:	DP40